

Unraveling the Rules of Rifts

Paul E. Olsen and Roy W. Schlische

The stratigraphic and sedimentological patterns seen in continental rift basins appear to follow rules based on the relationship between the basin's growth through time and the resulting change in area of the depositional surface as the basin fills. Using relatively simple models based on these rules we can separate the real tectonic, climatic, and sedimentological "events" from the unfolding of the necessary consequences of the filling of a trough.

What are the first-order rules governing the stratigraphic sequences in continental rift basins? Are sedimentation rates or types of depositional environments controlled directly by movements along the basin's boundary faults or by climate or by regional relief? Are rates of extension relatively constant or spasmodic? These fundamental questions about the rifting process have largely remained unexplored at least partly because these basins lack the fixed reference frame provided by a sea-level datum. As presently understood, the stratigraphy of continental extensional basins is generally described in historical narrative style with each major change in depositional environment and sedimentation being interpreted as a result of some unique event. Thus the tectonic and stratigraphic histories of these rift basins read like a series of disconnected causes and effects without causal generalities. Our understanding of synrift deposits, thus, stands in rather marked contrast to the elegant models that explain post-rift passive margin stratigraphy in terms of thermally driven subsidence, sediment compaction, and global sea level change.

Changes in depositional surface area due to basin growth and filling must profoundly affect rates and modes of sedimentation. In hydrologically closed basins these epiphenomena can dominate the stratigraphic pattern. We are developing a series of models for continental extensional basins which allow these basin filling effects to be subtracted from the sedimentary record, thereby revealing a residuum of real historical changes in more fundamental underlying tectonic, climatic, and biological patterns. This process is analogous to extracting a sea level curve from a passive margin subsidence curve by removing the thermal effects. Here we show how these models can be applied to the classic rift basins of eastern North America (Fig. 1).

Geologic Background

Eastern North America includes the classic Atlantic-type passive continental margin formed by the breakup of the supercontinent of Pangea. The Triassic initiation of the breakup was marked by the formation of rifted crust all along the axis of the future Atlantic, from Greenland to Mexico. In eastern North America, 13 major rift basins, mostly half-graben, and several minor basins are exposed from Nova Scotia to South Carolina,

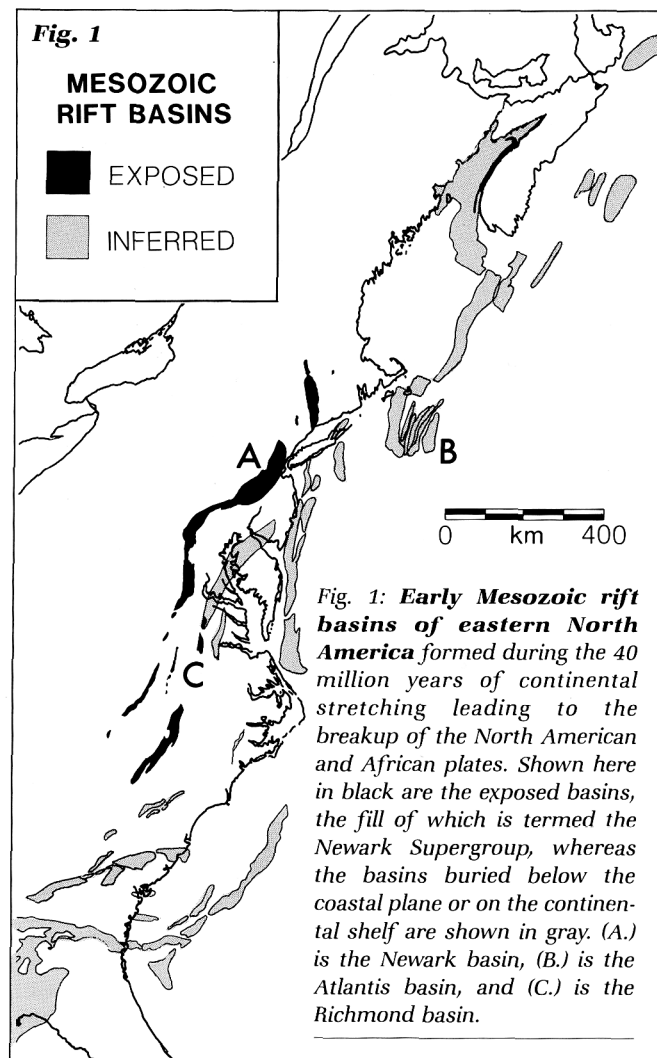

with many more buried below the coastal plain and on the continental shelf (Fig. 1). The exposed rift basins, which closely follow the trend of the Appalachian orogen, filled with thousands of meters of continental sediments, minor mafic volcanic rocks, and diabase plutons and dikes over a period of 45 million years. The faulted, tilted, and eroded rift strata are termed the Newark Supergroup.

Based on surface geology and seismic reflection profiles, the basin fill is wedge-shaped and thickens toward the border fault side of the basins (Fig. 2). In addition, younger strata (layered sedimentary rocks) progressively onlap the basement block in the hanging wall of the border fault (the block of rock above a

Fig. 2: Cross section and seismic reflection profiles through rift basins in Eastern North America (A. and B.) and Nevada (C.) show similar patterns. All are half-graben, which are asymmetric basins bound by predominately normal faults (shown with half-arrows), with basin strata tilting toward and thickening toward the faults. Clearly younger sedimentary strata occupied basins which had grown in size through time, indicating that the depositional surface also grew in area through time. In the Newark basin, abbreviations for stratigraphic units are: S, Stockton Formation; L, Lockatong Formation; P, Passaic Formation; E, Zone of lava flows and interbedded sediments; and J, Intrusive mafic plutons, including the Palisades Sill on which Lamont sits. Scale bars all represent 5 km.

fault), as first noted by Charles Lyell in 1845 in the Richmond basin of Virginia (Fig. 1C) and as seen in seismic reflection profiles. These onlap relationships are not just found in rift basins of eastern North America, but are also seen, for example, in the Railroad Valley basin in the Basin and Range of Nevada, and hence may be a general half-graben feature (Fig. 2). The onlap relationships indicate that the strata progressively filled rift basins which had grown in size through time. More significantly to the basin filling model presented below, the depositional surface area also grew through time. The depositional surfaces are shown in two dimensions by the dotted lines in Fig. 2A and by the thin solid lines in Fig. 2B and 2C.

Except for the predominantly fluvial (alluvial fan, river and stream) sediments that characterize the oldest (and sometimes the youngest) fill of the basins, most Newark Supergroup sediments fit a closed basin model. When enough water entered the basins, perennial lakes formed instead of through-going rivers.

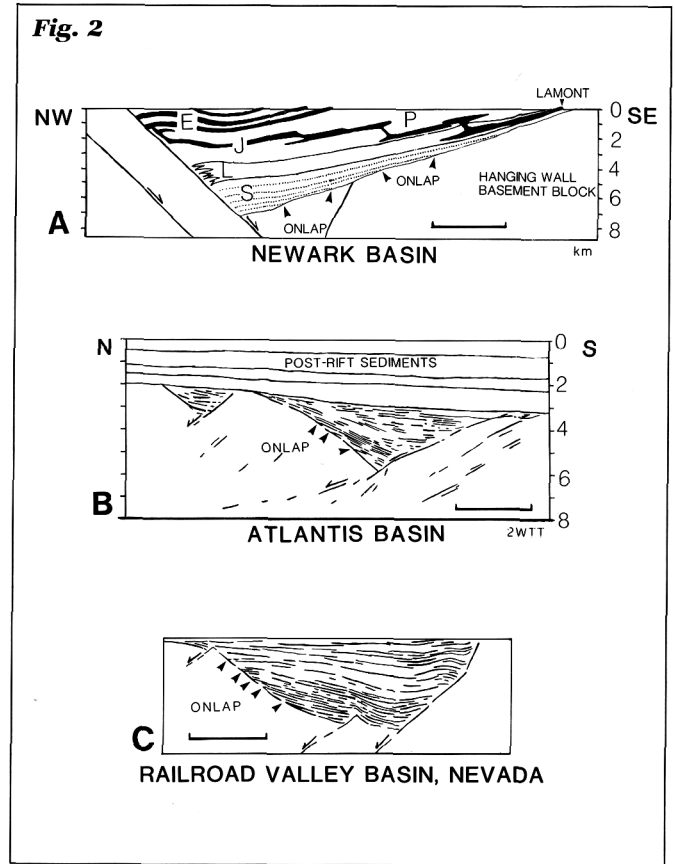
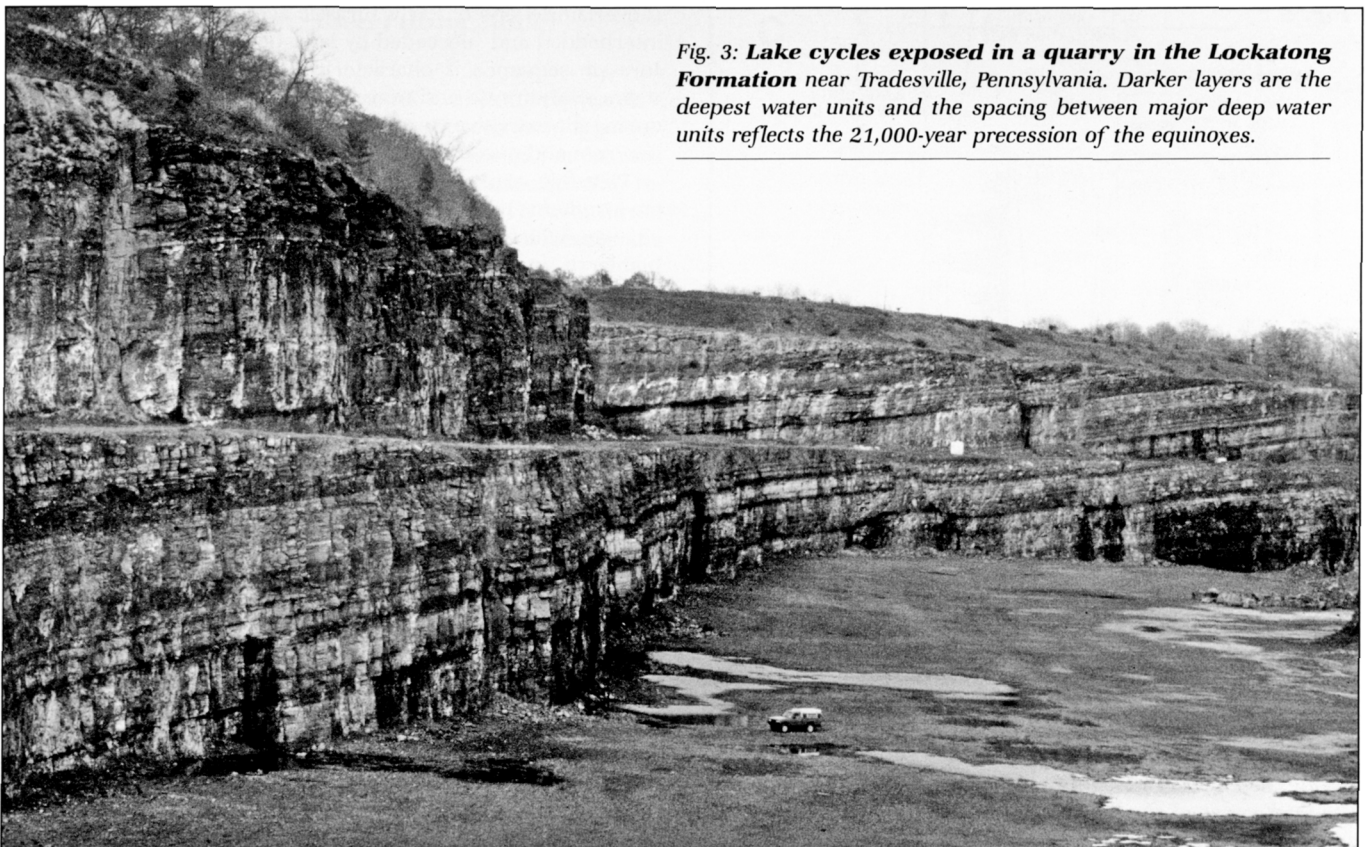

Fig. 3: Lake cycles exposed in a quarry in the Lockatong Formation near Tradesville, Pennsylvania. Darker layers are the deepest water units and the spacing between major deep water units reflects the 21,000-year precession of the equinoxes.



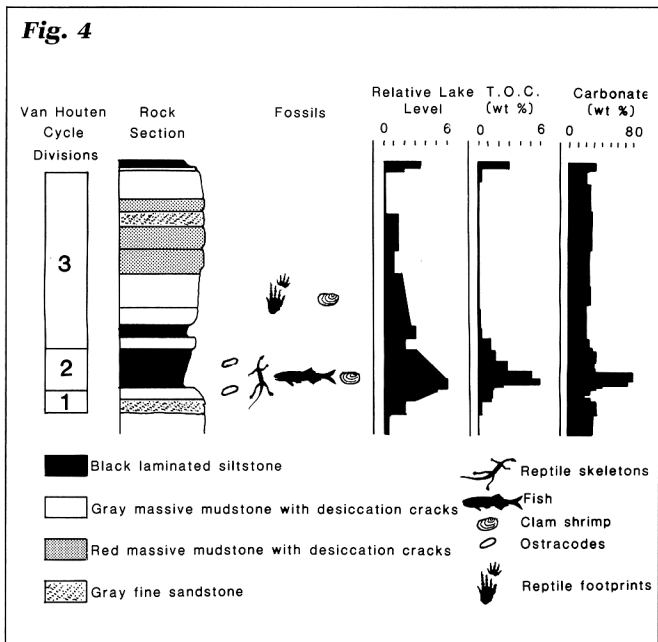

Fig. 4: **Generalized 21,000-year (Van Houten) lake cycle** caused by lake level rise and fall governed by the precession of the equinoxes according to the Milankovitch theory of climate change. Depth rank is a classification of sedimentary fabrics according to the inferred lake depth at the time of formation (0 representing shallow water, 6 representing deep water).

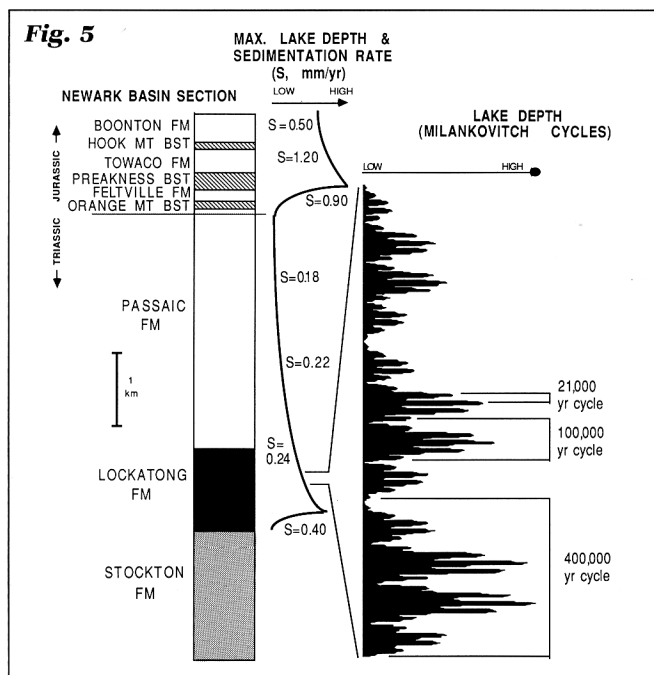

Fig. 5: **Stratigraphic pattern seen in the Newark Basin.** Maximum lake depth is simply the enveloping surface of the Milankovitch-period lake-level fluctuations, which represents the maximum depth lakes attained during the wettest of climate cycles. The thicknesses of the 21,000-year cycles were used to calculate the sedimentation rates in this figure.

Lake sediments thus dominate the Newark succession, interfingering with coarser alluvial and fluvial sediments around the edges of the basins (Figs. 3–5). The key to the quantitative application of our extensional basin-filling models is the extraordinarily fine-scale resolution provided by lake-level cycles which constitute these lacustrine rocks (Figs. 3 and 4). These cycles were produced by the rise and fall of lakes, controlled by periodic changes in climate, which were, in turn, controlled by variations in Earth's orbit following the Milankovitch theory of climate change. The thicknesses of the 21,000-, 100,000-, and 400,000-year cycles (see Fig. 5) have allowed us to measure sedimentation rates (thickness divided by time) through most of the Newark basin's stratigraphic column.

The stratigraphic sequences in most exposed Newark Supergroup rift basins fall into two distinct categories, distinguished by age and stratigraphic pattern, as exemplified by the stratigraphy of the Newark basin, in which Lamont itself is located (Fig. 2). The older (Triassic age) sequence consists of a basal red and brown fluvial interval (Stockton Formation) overlain by a gray and black lacustrine sequence (Lockatong Formation, Fig. 3), which is succeeded by an upper, mostly red, lacustrine interval (Passaic Formation, Fig. 5). Sedimentation rates show a slow and steady decrease after the onset of lacustrine deposition (see Fig. 7B). Maximum lake depth (during the wettest portions of climate cycles, Fig. 5) began shallow, rapidly deepened, and then slowly and exponentially shallowed through the close of the Late Triassic (Fig. 5). [Lake depth is estimated by examining the sedimentary fabrics of the rocks and by knowing something about the size of the lakes. For example, mudcracks indicate that the lake had dried up, whereas exquisitely preserved fish fossils indicate a lake deeper than 200 m in a basin the size of the Newark basin.] This lower Triassic-age sequence is overlain by one of Early Jurassic age consisting of lava flows interbedded and succeeded by lacustrine sediments. The Early Jurassic sequence is characterized by a marked increase in sedimentation rate and maximum lake depth just prior to and during the extrusive episode (Fig. 5); thereafter, both sedimentation rate and maximum lake depth decreased.

Plausible explanations for the transitions in depositional environments in the Triassic-age strata have included "tectonic" changes which altered the height of the outlet, relief in the highlands, increases or decreases in fault activity, variations in sediment supply, or any number of other factors. Because the timing of the depositional changes were different in each basin, the tectonic history of each basin would thus appear unique. As previously discussed, the geometry of the basin fill implies that the basins were growing in size through time, suggesting that the depositional surface was also growing in area through time. These observations and the changes in sedimentation rates suggest a new model analogous to the filling of a concave vessel. In this new "basin filling model" the geometric consequences of the passive filling of the rift basins are major controls on sedimentation style and rates.

Basin Filling Model for a Full-Graben

A geometrically simple example of a basin filling model is that of a full-graben bound by planar faults, where uniform extension results in uniform subsidence (Fig. 6). As the graben subsides and sedimentation proceeds, the area of the depositional surface increases. Therefore, assuming the other variables to be constant—notably the volumetric sedimentation rate (volume of sediment added per unit time)—then the classical sedimentation

rate (thickness divided by time) must decrease as a natural consequence of the growing depositional surface area, because as a constant volume of sediment is spread over a larger and larger area, the thickness of sediments deposited per unit time must decrease.

Although the basin geometry is very simple, the consequences of this type of model are profound for basin stratigraphy. If the basin subsides fast enough or the volumetric sedimentation rate is small enough, the basin will never fill, and lacustrine deposition will occur from the outset. Sedimentation rate will show a slow decrease through time. If, on the other hand, the subsidence rate is slow enough or the volumetric sedimentation rate is large enough, the basin will initially fill with fluvial sediment and excess sediment and water will leave the basin (a in Fig. 7A). However, as the basin continues to subside, the same volume of sediment will be spread over a larger and larger depositional surface. At some point, the volume of sediment added will be just enough to fill the basin; thereafter, sediment will no longer completely fill the basin, and lacustrine deposition will begin. Sedimentation rate will then decrease (b-e in Fig. 7B). At the onset of lacustrine sedimentation, maximum lake depth will be shallow but will steadily and rapidly increase as the distance between the basin's outlet and the depositional surface grows (b in Fig. 7C). However, since the supply of water is not infinite, a volume of the lake will be reached when the water surface just reaches the outlet. This is the deepest lake possible in the basin. Thereafter, maximum lake depth will slowly and exponentially decrease through time (c in Fig. 7C), as a result of the finite rate of inflow, the growing size of the basin, and losses due to evaporation on a lake whose surface area continually grows.

Comparison of Full-Graben Filling Model with the Newark Basin

Despite the oversimplification of the full-graben filling model, it yields sedimentological and stratigraphic patterns quantitatively comparable to the Triassic-age portions of the Newark basin when the appropriate parameters are selected. The resulting curves (Fig. 7) correctly predict the switch from fluvial to lacustrine deposition 2 m.y. after subsidence began, the

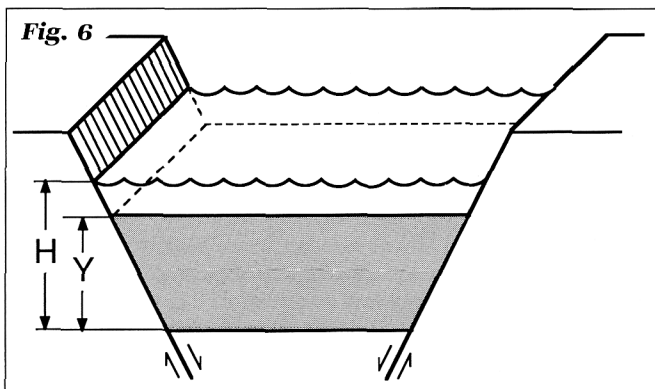

Fig. 6: **Full-graben model used to generate curves** in Fig. 7. A full-graben is a symmetrical basin bounded on both sides by normal faults (shown by the half-arrows). As the graben grows larger and larger through time, the thickness of sediment deposited per unit time must decrease. Y is the cumulative sediment thickness, and H is equal to maximum lake depth plus Y .

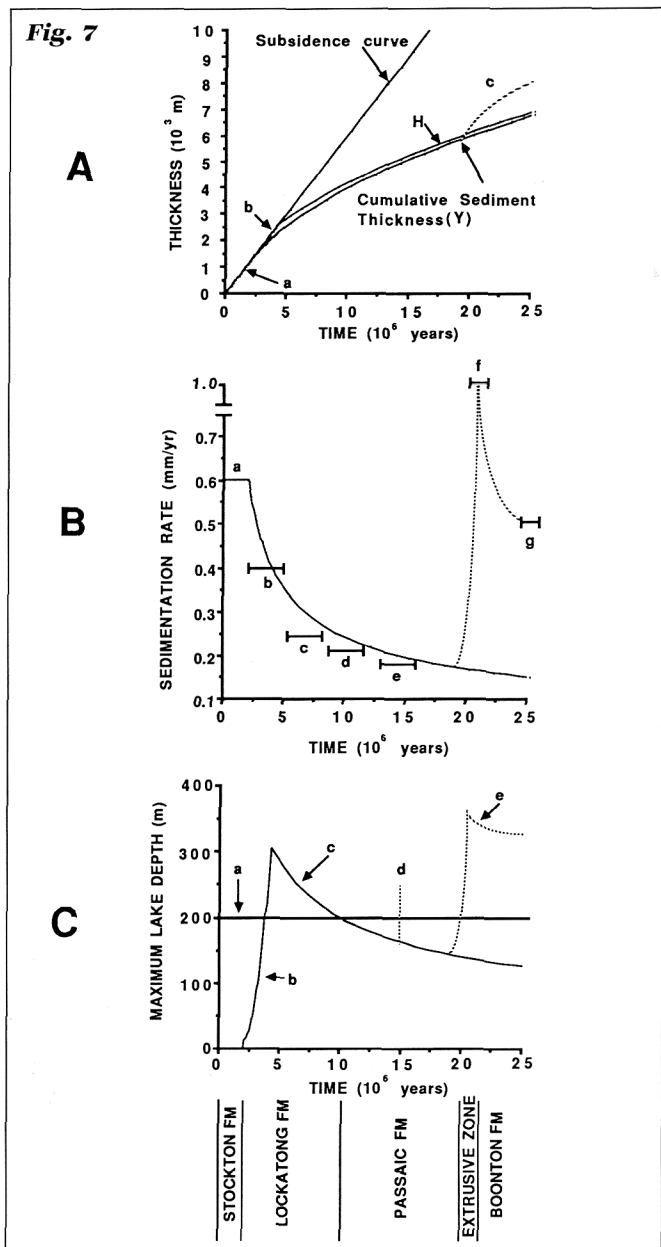

Fig. 7: **Predictions of the full-graben model** (solid lines) compared to data from the Newark basin (dotted lines and error bars). (A.) Model filling curves for the Newark basin. Abbreviations are: a, linear portion of filling curve equal to subsidence curve, resulting in fluvial sedimentation; b, region where lake depth is increasing due to subsidence of depositional surface below basin outlet; c, major deviation from cumulative thickness curve in the Early Jurassic. (B.) Sedimentation-rate curve is the derivative of cumulative thickness curve in (A.) Abbreviations are: a, fluvial interval, where sedimentation rate equals subsidence rate; b-g, data on sedimentation rate from scattered outcrops through center of the basin. (C.) Maximum lake depth curves. Abbreviations are: a, 200-m-depth line corresponding to wave base, above which microlaminated sediments cannot be deposited; b, rapid increase in lake depth based on relation in "b" part of curve in A.; c, slow decrease in maximum lake depth; d, "superwet" climatic anomaly; e, deep Jurassic lakes.

decrease in sedimentation rates after the onset of lacustrine deposition, the occurrence of the deepest lake in the lower Lockatong Formation, and the overall decrease in maximum lake depth thereafter. In addition, the curves show that the sedimentation rate in the fluvial Stockton Formation is equal to the subsidence rate of 0.6 mm/yr (a in Figs. 7A and 7B). The filling model also explains why the switchover from fluvial to lacustrine deposition should occur at different times in different Mesozoic basins of eastern North America: even if all the basins started subsiding at the same time, the time of the switchover is still controlled by basin geometry and the volumetric sedimentation rate.

Half-Graben Filling Models

The predictions of the full-graben model correspond remarkably to the observed Triassic stratigraphy of the basin fill of the Newark basin, yet the Newark basin is a half-graben. In a half-graben which is growing through time under conditions of uniform subsidence and constant volume input (as in Fig. 2), the changes in sedimentation rate and maximum lake depth should follow a similar pattern as for a full-graben as long as the depositional surface area increases through time. Unfortunately, working from first principles to produce a model for half-graben presumes we understand how half-graben evolved—which we do not. We are attempting to circumvent this problem by basing our models on the area of stratal surfaces within the basins themselves based on seismic profiles. We propose to select a volumetric filling rate based on the measured volume of a single lake cycle averaged over perhaps 100,000 years and then iteratively to fit this volume to successive interpolated stratal surfaces. Such an approach is inherently three-dimensional and requires excellent seismic and subsurface control. Furthermore, any deformation which destroyed the pristine “filling” geometry must be removed. At present, we have not yet reached that level of sophistication.

We can demonstrate the salient features of this method, however, by applying a two-dimensional approach to a hypothetical basin loosely based on the geometry of the Atlantis basin of the Long Island platform described by Debbie Hutchinson and Kim Klitgord of the USGS (Woods Hole), Figs. 2 and 8. In this example, a cross-sectional area of $1.5 \times 10^6 \text{ m}^2$ (the two-dimensional analogue of a sediment supply rate) was fit to the observed geometry of the half-graben. Stratal geometry and onlap relationships were maintained throughout the “filling process.” The graphs in Figs. 8B and 8C present cumulative thickness and sedimentation rate data based on the geometry generated in Fig. 8A for a “drill hole” through the deepest portion of the half-graben and for the “average” thickness of each 550,000-year depositional package. The form of the curves is similar to those generated for the full-graben case in Fig. 7. Therefore, because half-graben grow in size through time, under conditions of constant volume input, sedimentation rate must decrease through time as a predictable consequence of the evolving geometry of that basin. Half-graben are thus amenable to the same kind of analysis we have presented for the full-graben model, and we envision few difficulties in producing a three-dimensional half-graben model for the Newark basin, which agrees quantitatively with the observed Triassic-age part of the Newark basin section.

Despite our success in modeling the Triassic-age strata of the Newark basin, the predictions of both the full-graben and half-graben models are violated by the pattern seen in the Early

Jurassic-age sequences. These show increases in both sedimentation rate and maximum lake depth. In our full-graben model, once lacustrine deposition began and the deepest lake had been achieved, no change in subsidence rate could increase both sedimentation rate and maximum lake depth. These are governed solely by the area of the depositional and lake surfaces, respectively, which would not change even if subsidence were grossly increased.

On the other hand, half-graben subside asymmetrically, and an increase in subsidence rate should result in an increase in basin asymmetry. This would shift sediments and water to the

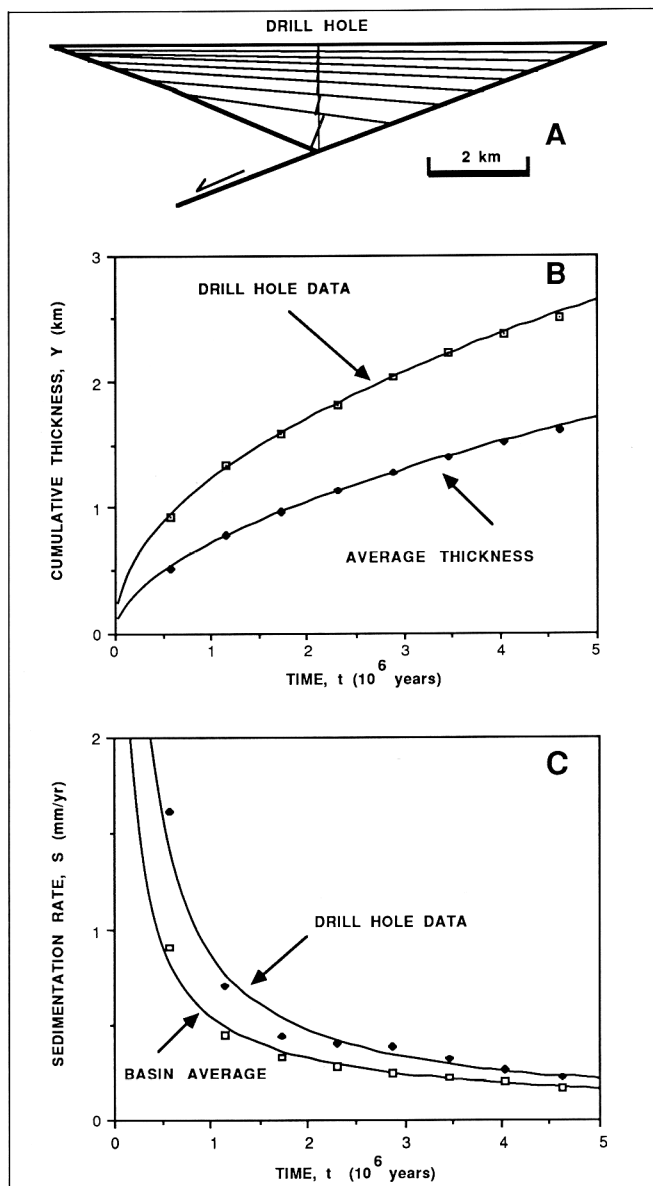

Fig. 8: **Half-graben model** showing predicted decrease in rate of filling with time. (A.) Cross section of hypothetical half-graben, loosely based on the geometry of the Atlantis basin (see Figs. 1 and 2), tilted lines are stratal surfaces successively fitted to an area of $1.5 \times 10^6 \text{ m}^2$ per 550,000 years. (B.) Cumulative thickness curves for the iteratively filled basin. (C.) Sedimentation-rate curves based on B.

border fault side of the basin. A rapid increase in basin asymmetry could therefore lead to a (temporary) decrease in the area of the depositional surface and lake surface area and a resultant increase in sedimentation rate and maximum lake depth. Uniform subsidence thereafter would again result in an exponential decrease in sedimentation rate and maximum lake depth.

It could be argued that a dramatic increase in the volume of sediment added per unit time would also increase the sedimentation rate. However, this added volume of sediment would fill the basin faster, increasing the depositional surface area faster, increasing the surface area of the lake, which in such an upward-widening basin has the effect of decreasing maximum lake depth. On the other hand, an increase in the maximum volume of water added to the basin during the wettest climate cycles would increase maximum lake depth and possibly bring in more sediments, increasing the sedimentation rate. However, this would imply that the sedimentation rate would be slower in the Van Houten cycles formed during the drier phases of the long (100,000- and 400,000-year) cycles, which is not the case. It therefore appears likely that the observed Early Jurassic increases in sedimentation rate and maximum lake depth were the result of an increase in basin asymmetry. This asymmetry may have been caused by a rapid change with depth in the geometry of the border fault system. However, because the observed increases in sedimentation rate and maximum lake depth occurred simultaneously in all of the rift basins, all of the border faults would have to have had the same peculiar geometry, which we deem unlikely. We therefore attribute the Jurassic "event" to a marked increase in regional extension, which significantly coincided with the brief but voluminous Newark Supergroup igneous activity. Further modeling with a more realistic half-graben model specifically based on Newark basin geometry should allow us to quantify the amount of this increase in extension rate.

An additional difference between the full- and half-graben models is how sedimentation rates will change after very long periods of subsidence. Theoretically in full-graben, sedimentation rates could continue decreasing indefinitely as the depositional surface became larger and larger. In marked contrast, half-graben sedimentation rates will cease to decrease once strata cease to onlap the hanging wall basement block but instead begin to onlap previously deposited strata. If subsidence continues long enough, this transition is inevitable. Consequently, the sedimentation rate will cease to change as the basin fills and the updip edges of previously deposited sediments (those furthest from the border fault) become exposed and subject to erosion.

In summary, under uniform subsidence and constant sediment supply, regardless of their magnitude, both the full- and half-graben models predict that if fluvial sedimentation begins when the basin is hydrographically open, there will eventually be a transition to a closed basin and a lake. Upon hydrographic closure, the sedimentation rate will slowly decrease until the depositional surface lies inside previously deposited sediments and then the basin will begin to consume itself. Both the full- and half-graben models predict that when subsidence ceases or slows sufficiently, fluvial deposition will again begin as the basin fills to its outlet and, if the subsidence were slow enough, the river system could in fact deepen the outlet and dissection of the basin would commence.

Utility of the Basin-Filling Model

The extensional basin-filling model provides a framework for understanding the stratigraphic succession within the basins of the Newark Supergroup and other systems of extensional basins. Many of the observed changes through the stratigraphic sequence may be explained simply as the consequence of the filling of a concave vessel, without recourse to complicated tectonic or climatic scenarios (e.g., the switch from fluvial to lacustrine deposition in the Triassic sequence and the decrease in sedimentation rate after the onset of lacustrine deposition). Previously, these would have been explained by variations in the rates and magnitudes of tectonic or climatic processes.

The basin-filling models make specific predictions of what sedimentation rate and environmental changes can be expected from changes in the underlying assumptions and, for us, this is where the real interest in these models lies. Thus, the Early Jurassic increase in sedimentation rate and maximum lake depth seen in the Newark Supergroup can be explained as an increase in extension rate associated with massive igneous activity. Other deviations from the predictions of the models reveal additional "events." For example, Fig. 7C(d) shows a marked departure in maximum lake depth in the Passaic Formation. This departure points toward a "super-wet" climate cycle, a clear violation of the initial assumptions. Without the basin-filling model this wet interval in the Passaic would be explained as just one of many large-scale fluctuations in climate supposed to have produced changes seen through the Newark basin record. Now with the basin-filling models accounting for most of the major changes in maximum lake depth and sedimentation rate, it stands out as something very unusual. Hence, the utility of the basin-filling model is now realized: we can subtract out from observed sedimentary record those effects which are solely the result of the filling of the basin (be they generated by an analytical forward model, as in Fig. 7, or iteratively, as in Fig. 8) and concentrate on the causes of those deviations, which result when the assumptions of the simple model (e.g., constant volume of sediment input per unit time, constant inflow rate of water, etc.) are violated. In addition, we can compare basins to identify local deviations vs. regional deviations (e.g., the Early Jurassic event which resulted from an increase in extension).

These models are obviously in their infancy: among other glaring omissions, we have neglected the effects of compaction, feedback relationships between erosion of previously deposited sediments and sedimentation rates, and the effects of changing relief during basin formation. We are in the process of addressing these complications. In addition, to test these models fully and use them, we need a much improved data base. Deep drill hole data (preferably cores) from the deepest parts of Newark basin will be needed along with high-resolution seismic profiles for rigorous analysis. Until that time, outcrop and short-core data will suffice to outline the broader picture and reveal problems. Ultimately, by combining the results of the basin-filling models with knowledge of how extensional basins grow and deform through time, we hope to document variations in extension rate through the history of Early Mesozoic rifting; understand the relationship among the sediment budget of a basin, changes in depositional environment, and the underlying tectonic processes; and identify unique climatic and tectonic events important on a regional scale.