

# HYDROACOUSTIC CALIBRATION WITH IMPLODING GLASS SPHERES

Jay J. Pulli<sup>1</sup> and Phil Harben<sup>2</sup>

<sup>1</sup>BBN Technologies; <sup>2</sup>Lawrence Livermore National Laboratory

Sponsored by U.S. Department of Energy  
Office of Nonproliferation Research and Engineering  
Office of Defense Nuclear Nonproliferation  
National Nuclear Security Administration

Subcontract Number B334423

## **ABSTRACT**

Calibration and validation of acoustic source and propagation models plays an important role in the hydroacoustic component of Comprehensive Nuclear-Test-Ban Treaty (CTBT) monitoring. This validation requires that we have a loud acoustic source with sufficient low-frequency energy that could be easily deployed in the Sound Fixing and Ranging (SOFAR) channel. SUS charges (Signal Underwater Source, 0.82 kg of explosive) have been used for this purpose for years, but safety and environmental concerns make these sources impractical. Light bulbs with sinkers have long been used as shallow acoustic sources, but are too small for the purposes stated. Here we describe investigations into the use of thin-walled glass spheres as calibration sources.

Since glass becomes stronger under pressure, a method is needed to reliably initiate the failure of the sphere at a specified depth. A prototype-smashing device, called a "spherecracker", was designed for this purpose. It consists of a 4-inch-diameter piston with a 1/4-inch diameter ram. The end cap on the device's cylinder tapers to a 1-inch diameter opening with a rupture disk calibrated to fail within 5% of the failure pressure. The ram initiates failure by punching a hole into the glass sphere.

In March 1999 we conducted an experiment with a 10-inch-diameter glass sphere at Dabob Bay, Washington. The sphere was tethered and lowered to a depth of 600 ft. A metal pipe was then slid down the tether line as a smashing device. This implosion produced a pressure pulse with peak amplitude of  $9 \times 10^{11}$   $\mu$ Pa at 1 meter and duration of 1 msec. The signal was recorded at a sampling rate of 100 kHz, and the spectrum shows energy from 50-50000 Hz. The low-frequency source level is approximately 200 dB re 1-uPa.

In February 2000 a test was conducted with a 22-liter glass sphere off the coast of San Diego at a depth of 685 meters in water that was 1200 meters deep. The Research Vessel (R. V.) Sproul was used to deploy the sphere. Implosion was initiated by the spherecracker. This implosion produced a pressure pulse with peak amplitude of  $2 \times 10^{13}$   $\mu$ Pa at 1 meter and duration of 1 msec. The signal was recorded at a sampling rate of 48 kHz, and the spectrum shows energy from 50-20000 Hz. The low frequency source level is approximately 190 dB re 1-uPa.

Included in this paper are long-range hydroacoustic propagation predictions using the program HydroCAM with each of these source measurements.

**Key Words:** Hydroacoustics, calibration, sources, glass spheres

## **OBJECTIVE**

The objective of this work has been to investigate the feasibility of using imploding glass spheres as deep-water acoustic sources for calibration experiments under the hydroacoustic component of nuclear explosion monitoring. Like its counterpart in seismic monitoring, hydroacoustic monitoring requires ground truth for both model validation and the interpretation of observed data. Explosive charges have long been used for this purpose, but safety and environmental concerns often preclude their use for research, especially by university groups. Airgun sources, typically used for oil and gas exploration, operate near the surface and are not designed for operation at the SOFAR

channel depths (500-1200 meters) required for this research. If a safe, reliable, and inexpensive source could be developed for operation at these depths, it could be used to:

- Calibrate long-range propagation travel-time predictions
- Assess the importance of horizontal refraction for long-range propagation
- Study T-wave coupling at continental margins
- Investigate the nature of acoustic scattering at bathymetric features
- Look for reflected arrivals from events which occur in predicted shadow zones
- Determine whether or not shadow zones behind islands are filled in by diffraction

The need for an inexpensive source that would operate in the SOFAR channel and does not have the hazard and safety procedure problems of explosives was recognized in the recent International Workshop on Hydroacoustic Monitoring for the CTBT that met in Tahiti in late September 1999 (Massinon, 1999). The workshop findings identify acoustic source development as a technical issue and advocate an approach to the problem that addresses the safety issue and the need for low-cost expendable sources.

## **RESEARCH ACCOMPLISHED**

### **Background**

Implosion sources have been used in specialized oceanographic studies for nearly 50 years. In 1952, 0.01-liter glass floats were imploded as an acoustical signal for indicating that a sediment corer reached the ocean bottom (Isaacs and Maxwell, 1952). In 1976, a study used weakened glass spheres to vary the depth of implosion (Orr and Schoenberg, 1976). More recently (1996), a project to develop a deep-water ocean bottom implosive source using a 20-liter cylinder was conducted (Sauter et al., 1996). Light bulbs with lead sinkers are often used today in shallow water experiments to test hydrophone operation. We do not know of an existing implosion system suited to the hydroacoustic monitoring needs at SOFAR channel depths. Any development of such a system must show its utility by demonstrating good source properties (amplitude and frequency content), implosion depth control, reliability, repeatability, and long-range propagation of the signal.

### **Acoustic Properties of Imploding Spheres**

An imploding source exploits the pressure difference between an enclosed volume of gas at nominal atmospheric pressure and the external water pressure at the implosion depth. A sudden catastrophic failure of the containing vessel leaves the relatively low-pressure gas bubble exposed to relatively high-pressure water and a rapid implosion ensues. The implosion momentum collapses the bubble radius to less than that required for an equilibrium pressure balance. At the instant of minimum bubble radius, the bubble begins expanding and radiates a positive acoustic pressure spike. This oscillation can continue for a few cycles, each with successively reduced pressure spikes as energy is dissipated and the bubble approaches a static equilibrium pressure. One distinct difference in the case of underwater explosions is the initial shock wave caused by ignition of the explosive and creation of the expanding gas globe, which consists of explosion gas products. There is no such analogue in an implosion. Another important difference is the relatively cold low-pressure gas inside the sphere compared to the high temperature dense explosive gas products in the gas bubble. The bubble collapse details of the two cases cannot be directly compared.

### **The Sphercracker**

If a glass sphere is of sufficient volume to produce the desired source signal level and has sufficient wall thickness to survive the water pressures in the operational depth range, then sphere failure must be initiated by some controlled method at a predetermined depth. Such a device was designed and built for this study and is termed by us the *Sphercracker* (Harben et al., 2000).

The *Sphercracker*, shown in Figure 1, was designed to be rugged enough to be reusable, heavy enough to sink the whole assembly loaded with the sphere, and not dependent on stored energy at the surface (i.e. no electricity or

compressed air). The device consists of two orthogonal cutout plates that hold the sphere and a cylinder-piston-ram assembly that punches a hole in the sphere. The system firmly holds the sphere in place and in contact with a 4-inch-diameter piston. A 1/4-inch diameter ram is connected to the center of the piston and passes through a small O-ring sealed hole in the cap confining the piston and abutting the glass sphere. The ram initiates failure by punching a hole through the glass sphere. The end-cap on the cylinder confining the piston and opposing the ram end-cap tapers to a one-inch diameter opening with a rupture disk seated to it. The rupture disk is calibrated to fail within 5% of the calibrated failure pressure of 1000 psi. Failure of the rupture disk results in an inrush of high-pressure water into the air-filled piston chamber, driving the piston - and attached ram - towards the glass sphere.

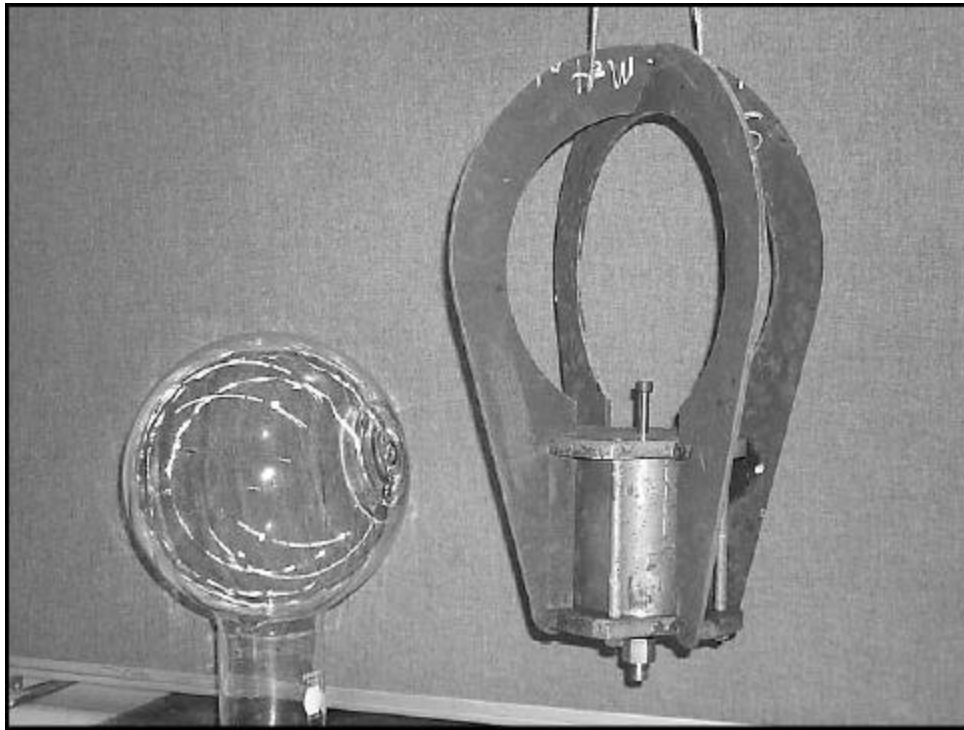

Figure 1. The *Sphercracker* is shown on the right in the lowering position. The piston assembly, shown in detail in Figure 2, is at the bottom of the mechanism. A Kontes glass sphere is shown on the left atop a laboratory beaker.

The operational concept is illustrated in Figure 2. Note that as the cylinder is lowered in the water, the water pressure on the ram serves to "cock" or position the piston near the rupture disk. When the disk fails, the water pressure on the relatively large area of the piston results in a force much greater than that on the small area opposing it. The net force drives the piston and the ram downward.

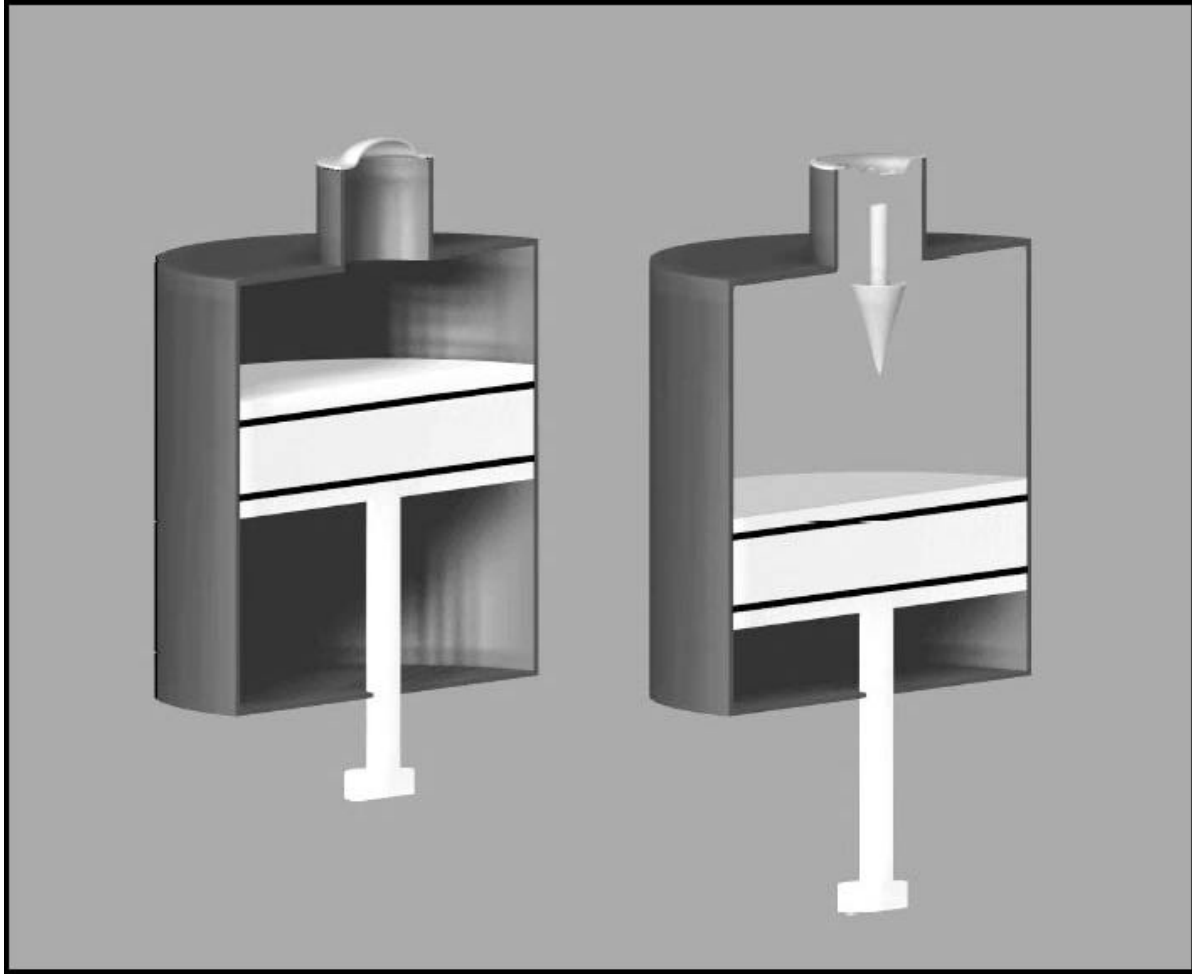

Figure 2. Conceptual view of the *Sphercracker* piston assembly. The rupture disk at the top keeps the cylinder volume above the piston at nominal atmospheric pressure (left). When the disk fails (right), high-pressure seawater rushes into the cylinder, driving the piston and ram downward.

#### **Field Test at Dabob Bay, WA - March 1999**

In March 1999 we conducted a test of an imploding glass sphere at Dabob Bay, WA. The purpose of this test was to record the source signal generated by the implosion and to estimate its source level. We used a 10-inch-diameter thin walled glass sphere that was lowered to a depth of 450 ft from a test barge (see Figure 3). Sandbags were used to sink the sphere to the test depth. The water depth at this site was 600 ft. Two hydrophones were used to record the implosion: one at a depth of 90 ft and one at a depth of 150 ft. A steel pipe was then slide down the tether line as a simple means of smashing the sphere and initiating the implosion (the *Sphercracker* was not available for this test). A Metrum tape recorder operating at 150,000 samples per second was used to record the implosion signal.



Figure 3. A 14-inch-diameter glass sphere is lowered into the water (left) during the March 1999 test conducted at Dabob Bay, WA. The sphere was lowered to a depth of 450 ft. A metal pipe was then slid down the tether line (right) in order to initiate failure. The water depth was 600-ft. Photos © by Ted Farrell.

The signal at the 150-ft hydrophone was clipped but the 90-ft hydrophone produced excellent data for analysis (see Figure 4). The recording, which was made at a horizontal offset of 33 meters from the source, shows three groups of arrivals: the sphere implosion followed by its bubble pulse, the inverted surface reflection of these signals, and finally the bottom bounce. Measured arrival time differences confirmed the implosion depth and hydrophone location. Figure 5 shows a blowup of the initial implosion signal. Note the precursor before the main signal, which appears in both the implosion and the bubble pulse. This may indicate that the sphere imploded in two steps. The width of the main signal is approximately 1/2 msec. The bubble pulse period is 4 msec.

The spectrum of the main implosion signal and the pre-event noise is shown in Figure 6. Ambient noise at this site is very low, so the signal-to-noise ratio is nearly 60 dB from 10-1000 Hz. Corrected to a source distance of 1-meter, the source level at 10 Hz is approximately 200 dB re 1-uPa.

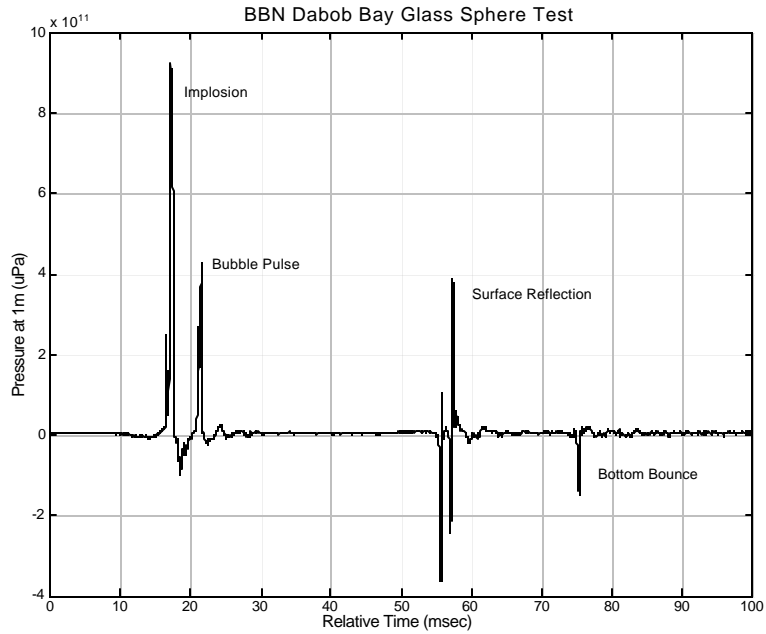

Figure 4. Recording of the glass sphere implosion test at Dabob Bay on the 90-ft hydrophone. Note the impulsive signal of the implosion, followed by the bubble pulse, then the surface reflection of the implosion and bubble pulse, and then the bottom reflection.

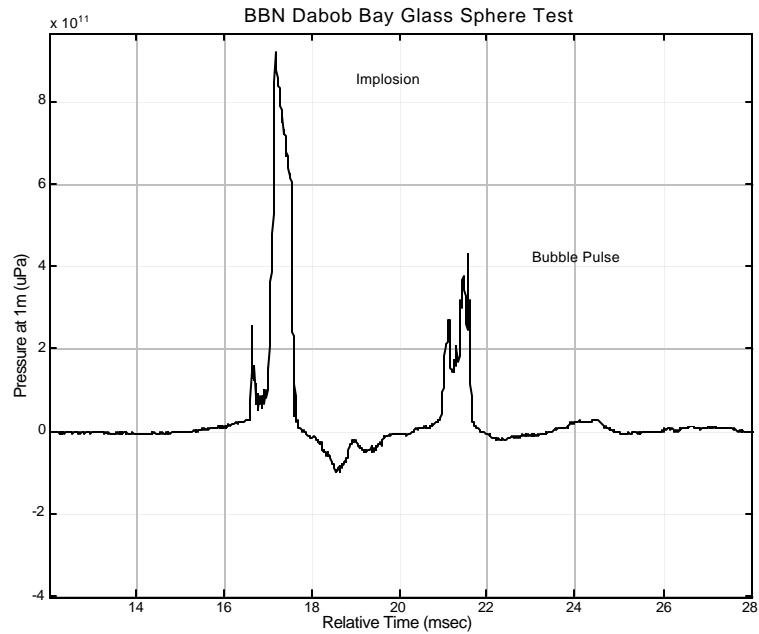

Figure 5. Blow-up of the sphere implosion waveform and its bubble pulse. Note the precursor before the main signal, which appears in both the implosion and the bubble pulse. The bubble pulse period is 4 msec.

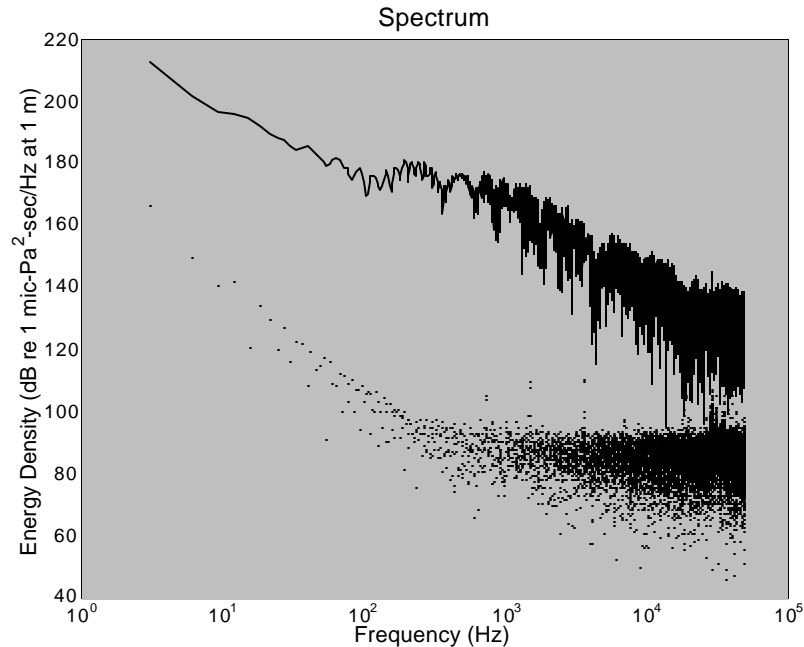

Figure 6. Spectrum of the Dabob Bay glass sphere implosion signal and pre-event noise corrected to a source distance of 1-meter. The source level at 10 Hz is approximately 200 dB re 1-uPa.

### Field Test West of San Diego - February 2000

An opportunity to conduct a field test of a CGS sphere and the *Spherecracker* came in February 2000. The *Spherecracker* was loaded aboard the Research Vessel Sproul and tested west of San Diego at a water depth of around 1200 meters. The *Spherecracker* was loaded with a 22-liter CGS glass sphere and was lowered until a 1000 psi rupture disk failed. After initiating a successful implosion, the *Spherecracker* was recovered undamaged. By reloading the device with a new pressure disk and glass sphere, it could be used repeatedly.

The impulsive signal recorded from the implosion allowed accurate determinations of hydrophone depth, implosion depth and water depth from the surface reflected, bottom reflected, and 2<sup>nd</sup> bottom reflected phases. The implosion occurred at 685 meters depth. The implosion signal was felt on the ship and recorded by a calibrated hydrophone suspended 12 meters deep. The recorded signal, shown in Figure 7, was of short duration (less than 5 msec) and with a small bubble pulse about 2 msec after the main collapse. The event starts with a rarefaction as the sphere shatters and collapses. The large compressional pressure spike following the rarefaction occurs when the collapse reaches a minimum volume and reverses (begins expanding).

The spectrum of the implosion and the pre-event noise is shown in Figure 8. The source does not show any appreciable acoustic energy above background noise for frequencies below about 50 Hz. Above 50 Hz the source amplitude rises to a broad maximum for frequencies between 200 and 800 Hz. There is a relatively shallow high-frequency roll-off of the source energy between 1 kHz and 10 kHz, whereas the noise rolls off more steeply in this band. The consequence is that the signal-to-noise ratio is highest at the highest frequency shown.

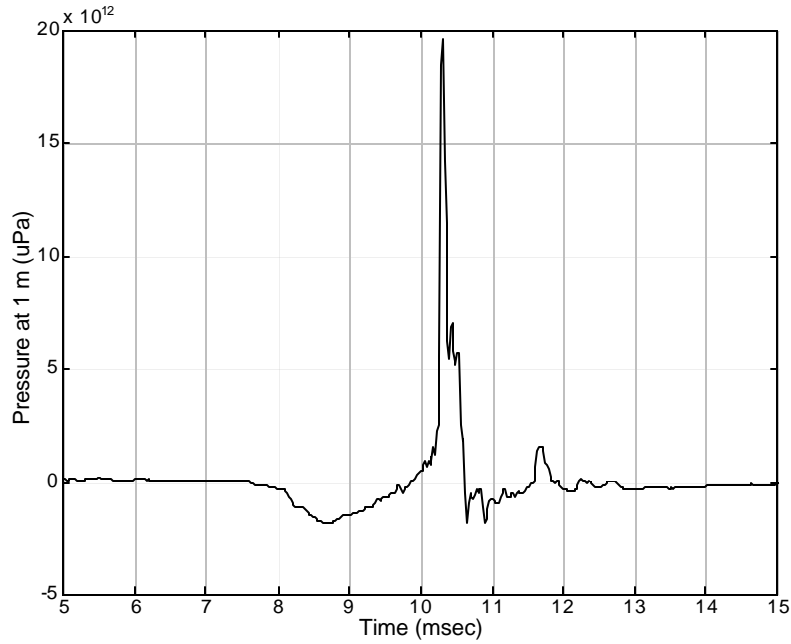

Figure 7. Waveform (left) recorded for the glass sphere implosion test off San Diego. The event starts with a rarefaction as the sphere shatters and collapses. The large compressional pressure spike following the rarefaction occurs when the collapse reaches a minimum volume and reverses (begins expanding).

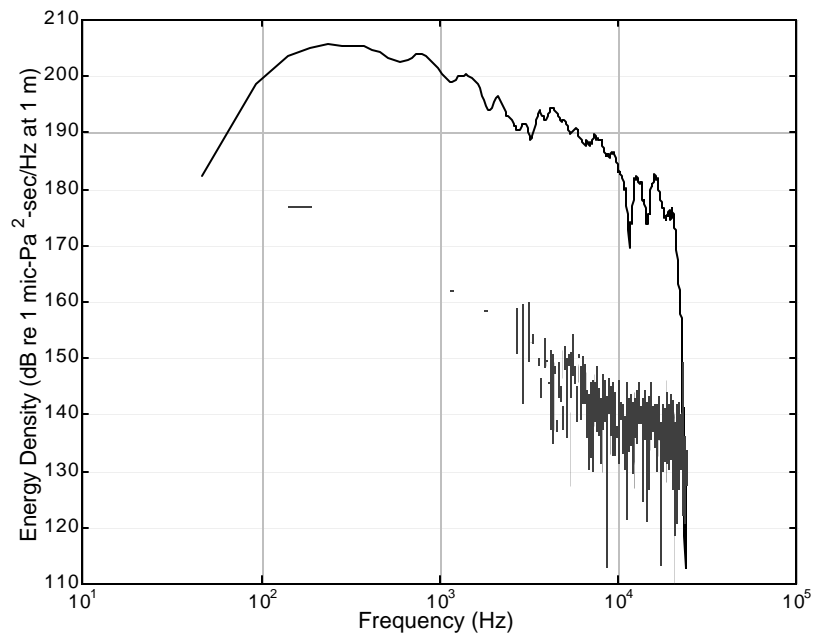

Figure 8. Spectrum of the glass sphere implosion test off San Diego. The peak of the spectrum is shifted toward the higher frequencies with respect to that seen for the Dabob Bay test. Source levels are on the order of 205 dB re 1-uPa at 200 Hz.



## Potential Use as Calibration Sources

At the beginning of this paper we listed a number of potential experiments that could be conducted with imploding glass sphere sources. Using the source measurements made in this study, we now calculate how far acoustic energy would travel in the SOFAR channel from an imploding glass sphere. The calculation, shown in Figure 9, used an imploding glass sphere in the SOFAR channel near Ascension Island in the South Atlantic Ocean. Propagation characteristics were calculated for a frequency of 10 Hz. A source level of 205 dB re 1-uPa was used. The figure shows transmission loss calculated out to a level of 125 dB, which would attenuate the source level from 205 to 80 dB re 1-uPa, which is the average background noise level in the Atlantic Ocean. The calculation demonstrates that the imploding glass sphere signal could be recorded above the background noise level across the entire Atlantic Ocean, making it an appropriate source for travel time calibration.

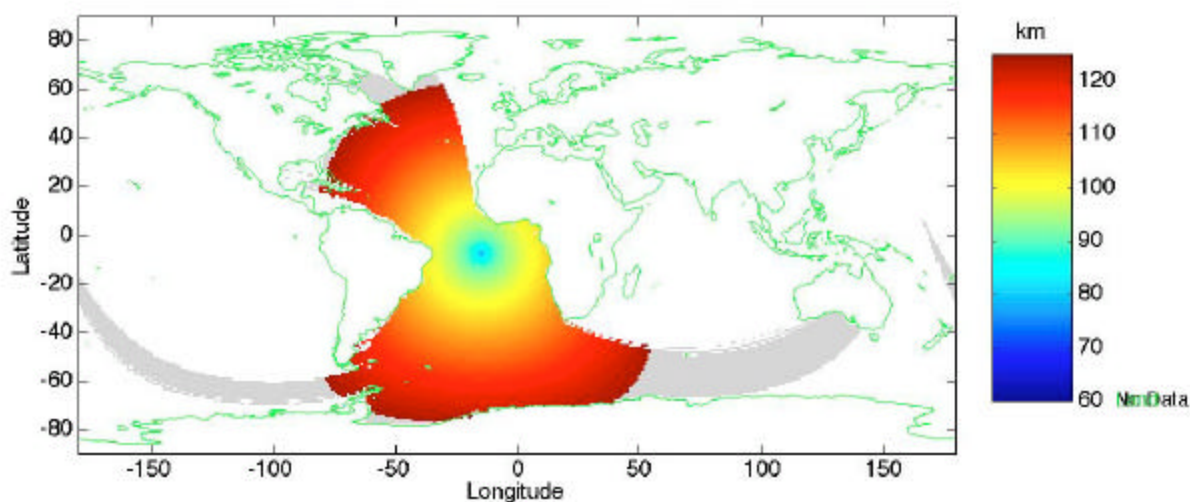

Figure 9. Model calculation of the attenuation of acoustic energy in the SOFAR channel from a 10-inch diameter glass sphere implosion near Ascension Island. Using a source strength of 205 dB re 1-uPa at 10 Hz, we used the program HydroCAM to compute the propagation out to a distance where the signal-to-noise ratio is 1:1 (based on average noise measurements of 80 dB re 1-uPa in the ocean). The calculation shows that the acoustic energy produced by the sphere implosion would be recorded across the Atlantic Ocean.

## CONCLUSIONS AND RECOMMENDATIONS

We have demonstrated the utility of using imploding glass spheres as calibration sources for the hydroacoustic component of nuclear monitoring. We conducted two experiments, one in Dabob Bay, WA and another off the coast of San Diego CA, where the source signals from the implosions were recorded and analyzed. A device termed a *Spherecracker* was designed and built to initiate failure of the glass sphere at a preset depth. Source levels of approximately 200 dB re 1-uPa were measured for the sources. In the Dabob Bay experiment, the imploding glass sphere produced sufficient low frequency energy to be useful for calibration experiments in the frequency range of interest to nuclear explosion monitoring. In the deeper water test off San Diego, the source spectrum was shifted to higher frequencies. Further work on the implosion phenomenology and field-testing is needed to understand this difference and make the source a productive tool for hydroacoustic research.

## **ACKNOWLEDGMENTS**

Ted Farrell, formerly of BBN Technologies and now at Johnson & Johnson, conducted the glass sphere test at Dabob Bay, WA. Charles Chassaing provided the shell theory background in order to assess whether or not a glass sphere would survive to SOFAR channel depths. We are also indebted to Donna Blackman and Tim Minshull for support of some early field tests. Support for the field test aboard the Research Vessel Sproul was provided by the National Science Foundation under grant OCE 97-12605.

## **REFERENCES**

- Harben, P.E., C. Boro, L.Dorman, and J. Pulli (2000), Use of Imploding Spheres: an Alternative to Explosives as Acoustic Sources at Mid-Latitude SOFAR Channel Depths, *Lawrence Livermore National Laboratory Report UCRL-ID-139032*.
- Isaacs, J.D. and A.E. Maxwell (1952), The Ball-breaker: a Deep Water Signaling Device, *J. Marine Res.*, *11*, 63-68.
- Massinon, B. (1999), Proceedings from the Informal Workshop on Hydroacoustics, Papeete, Tahiti.
- Orr, M. and M. Schoenberg (1976), Acoustic signatures from Deep Water Implosions of Spherical cavities, *JASA*, *59*, No. 5, 1155-1159.
- Sauter, A., L. Dorman and E. Canuteson (1996), Development of a Seismo-Acoustic Implosive Source, (abstract), Fall AGU Meeting, also at [www.mpl.ucsd.edu/obs/reports/ABM/implosive.agu.html](http://www.mpl.ucsd.edu/obs/reports/ABM/implosive.agu.html) .